

10 Schematic Diagrams

10-1 Main Part Schematic Diagram

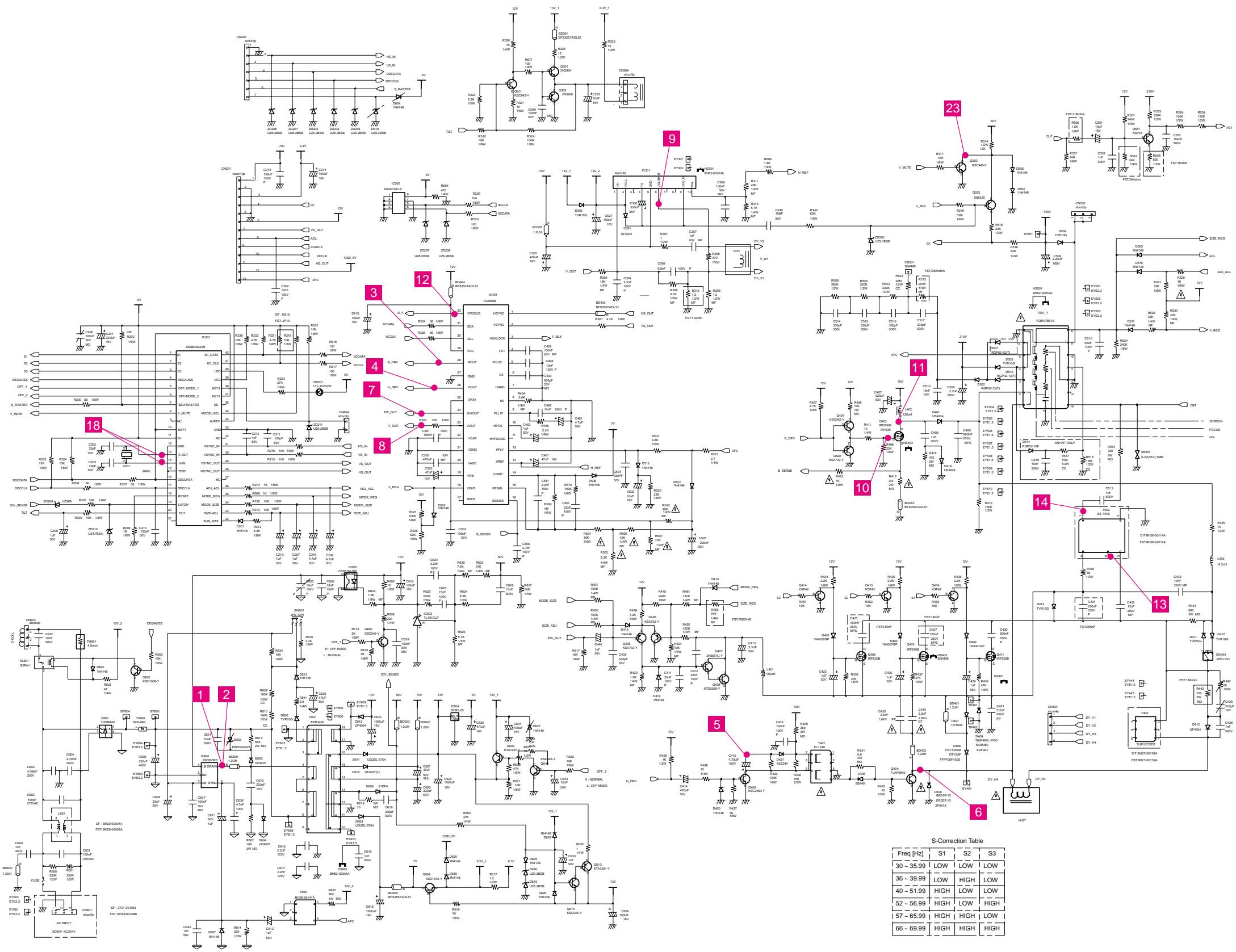

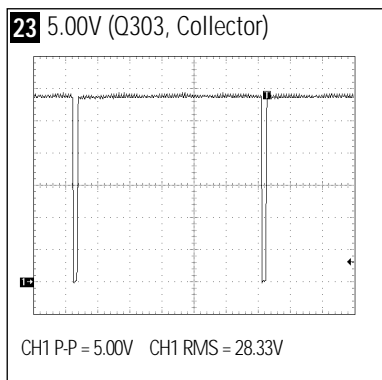
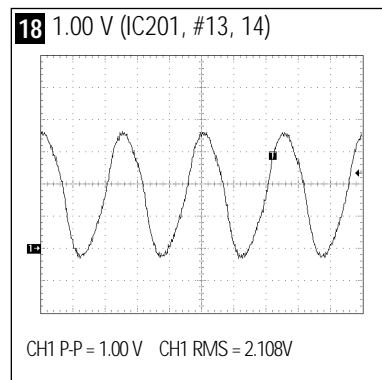
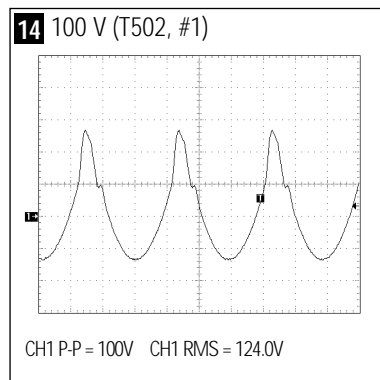
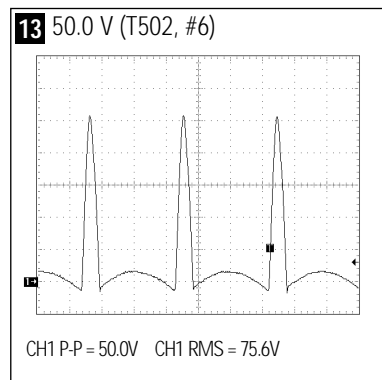
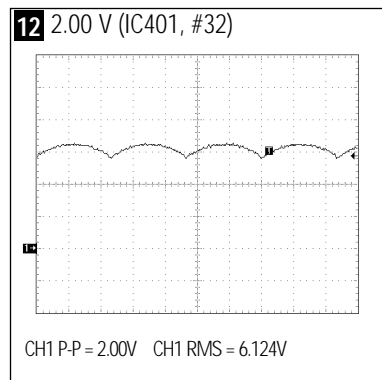
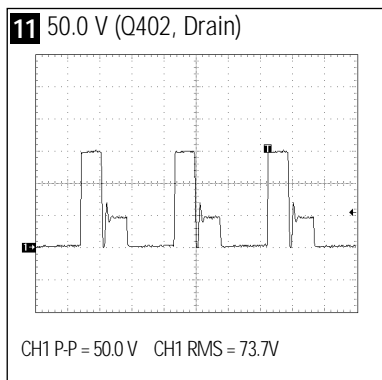
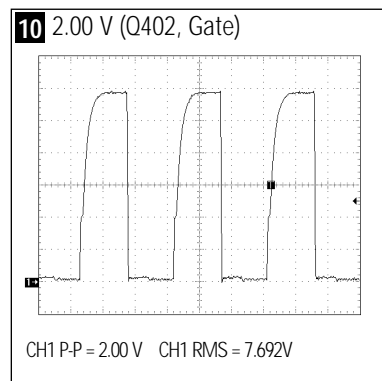
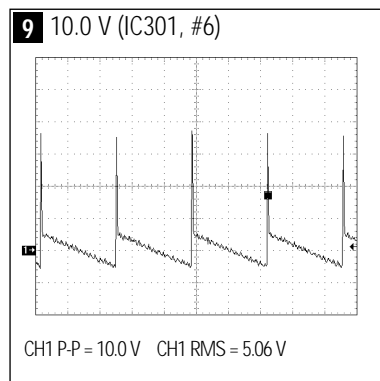
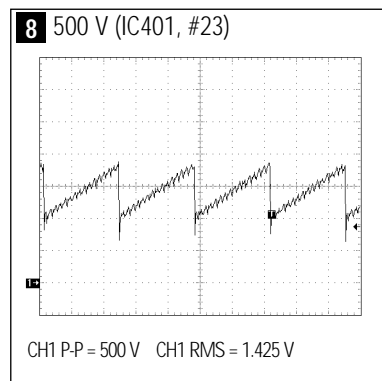
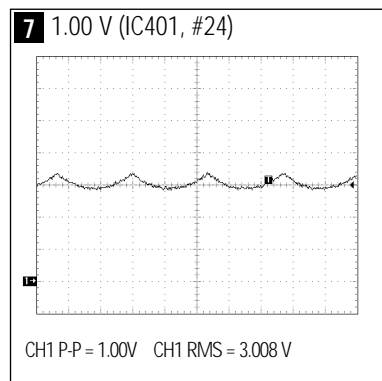
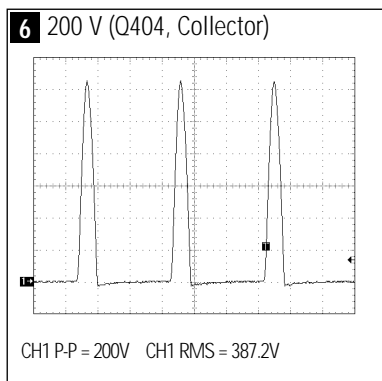
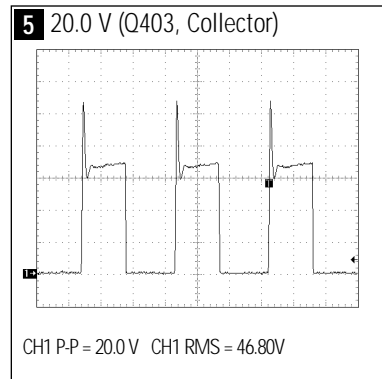
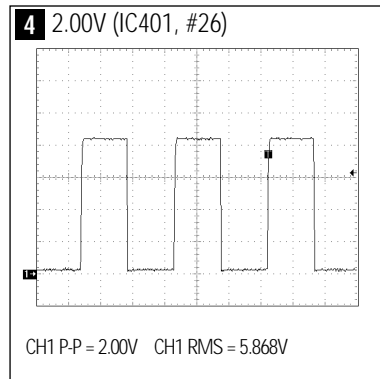
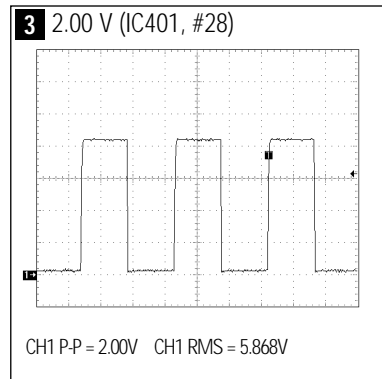
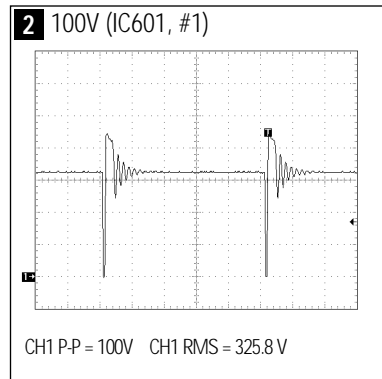
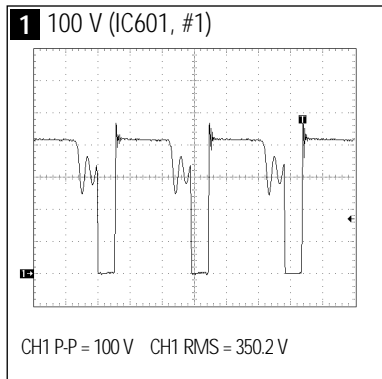

10-2 Video Part Schematic Diagram

